



Quality Tools for Smart Cleaning



RESERVEONDERDELEN 2024

PRODUCTASSORTIMENT

ZUIVER WATER SYSTEEM



Zuiver-water filters

HydroPower® DI Filter	3
HydroPower® RO M, RO L Filter	4
HydroPower® RO M, RO L Filter	5
HiFlo RO60C, RO60S, RO30G, RO30C Filter	6
HydroPower® RO XXL aanhanger	10

Watergeleidende steelsystemen

nLITE®	12
Snelkoppeling en hoes	13
nLite® Connect	14

KLASSIEKE GLASREINIGING



Telescoopstelen	16
Wissers	16
Schrapers	17

RAAM BINNENREINIGING



STINGRAY systeem	18
------------------------	----

ONDERHOUDSREINIGING



erGO! systeem	19
Gereedschapshouder	19
Dubbele rolemmers	19
Shop	19

ZUIVER WATER FILTER HYDRO POWER® ULTRA + DI



Quality Tools for Smart Cleaning

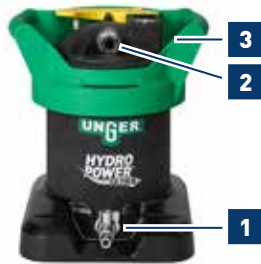

HydroPower DI
(2015-2019)



1 **HydroPower® ULTRA**
WATERINGANG VERCHROOMD MESSING
MED WATERKRAAN



Art. Nr.	VPE	€/stuk
21065	1 (incl. afdichtring)	30,77

1 **HydroPower® ULTRA**
DYNAMISCHE WATERSTROOMREGELAAR



Art. Nr.	VPE	€/stuk
23239	1 kit (5x)	18,45

2 **HydroPower® ULTRA**
WATERUITGANG VERCHROOMD MESSING



Art. Nr.	VPE	€/stuk
21064	1 (incl. afdichtring)	18,43

3 **HydroPower® ULTRA**
DEKSEL



Art. Nr.	Info	VPE	€/stuk
DIUTC	compleet, met TDS-meter	1	163,09
21072	zonder TDS-meter	1	97,90

3 **HydroPower® ULTRA**
AFDICHTINGSSET VOOR DEKSEL



Art. Nr.	Info	VPE	€/stuk
UHP5R	5x afdichtingsringen, onderhouszalf	1 kit	35,73

HydroPower® ULTRA
VERVANGENDE TANKS



Art. Nr.	Info	VPE	€/stuk
22269	Tank DIUH1 leeg	1	180,79
22271	Tank DIUH2/3 leeg	1	411,36

4 **HydroPower® DI**
WATERTOEVOERKLEP



Art. Nr.	VPE	€/stuk
18330	1	13,10

HydroPower® DI
ECO FLO



Art. Nr.	Info	VPE	€/stuk
18839	Vermindert de waterstroom	1	1,97

4 **HydroPower® DI**
WATERAANSLUITING MANNELIJK COMP.



Art. Nr.	VPE	€/stuk
18776	1	4,97

5 **HydroPower® DI**
WATERAANSLUITING VROUWELIJK COMP.



Art. Nr.	VPE	€/stuk
18775	1	4,97

6 **HydroPower® DI**
DEKSEL



Art. Nr.	Info	VPE	€/stuk
DITCP	compleet, met TDS-meter	1	139,50
18549	zonder TDS-meter	1	85,90

6 **HydroPower® DI**
AFDICHTINGSSET VOOR DEKSEL



Art. Nr.	Info	VPE	€/stuk
DISKT	5x afdichtingsringen, onderhouszalf	1 kit	22,50
19021	1x afdichtingsring	1	3,54

HYDRO POWER ULTRA + HYDRO POWER DI

	Art. Nr.	Product	Info	VPE	€/stuk	HP Ultra	HP DI
	21151	TDS METER	Inclusief batterijen: 2x LR44	1	40,96	✓	✓
	19038	SET WIELEN	4 wielen	1 kit	88,23	✓	✓
	20586	RESERVEWIEL	1 kit	1	56,31	✓	✓
	18503	TRANSPORTSTOP ROOD		1	0,21		✓
	23234	TRANSPORTSTOP GEEL		1	0,21	✓	✓
	22601	TRANSPORTWAGEN HYDRO POWER ULTRA		1	369,70	✓	
	18919	BEVEILIGINGSCLIIP VOOR TRANSPORTWAGEN		1	0,93	✓	✓

Ø 20mm

ZUIVER WATER FILTERS HYDRO POWER® RO S



RO S (R020C)



1 HydroPower® RO S
COMBIFILTER CHLOOR/SEDIMENTEN

Art. Nr.	VPE	€/stuk
ROCA2	1	15,66

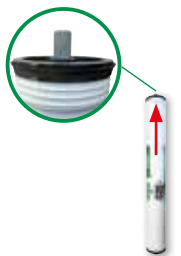

2 HydroPower® RO S
MEMBRANE

Art. Nr.	Product	VPE	€/stuk
ROME2	Membrane	1	459,88
22355	Afdichtring	1	2,30

Plaats het RO-membraan (ROME2) met de goede kant naar boven:

- De pijl moet naar boven wijzen.
- De rubberen afdichting moet altijd boven worden geplaatst!



3 HydroPower® RO S
HARS PATROON

Art. Nr.	VPE	€/stuk
RORE2	1	40,86

Plaats het DI harsfilter (RORE2) met de juiste kant naar boven:

Plaats het blauwe filterelement naar boven.

Onjuiste plaatsing van het filter kan het toestel beschadigen!



1
3 HydroPower® RO S
FILTER GEVAL COMPLEET

Art. Nr.	VPE	€/stuk
22345	1	64,89



1+2 HydroPower® RO S
FILTERSLEUTEL

Art. Nr.	VPE	€/stuk
22897	1	19,24



1 HydroPower® RO S ZUIGBUIS
VOOR MEMBRAAN-VERZORGINGSMIDDEL

Art. Nr.	VPE	€/stuk
22348	1	24,14



4 HydroPower® RO S
WATERINGANG VERCHROOMD MESSING
MED WATERKRAAN

Art. Nr.	VPE	€/stuk
22459	1 (incl. afdichtring)	30,78



4 HydroPower® RO S
WATER UIT AANSLUITING

Art. Nr.	VPE	€/stuk
ROWOT	1	19,29



4 HydroPower® RO DRIJKREGELAAR
Verlaagt de watertoevoerdruk tot 4 bar

Art. Nr.	VPE	€/stuk
18782	1	50,19



HydroPower® RO S
BESCHERMENDE CLIPS VOOR KAR

Art. Nr.	VPE	€/stuk
18919	1	0,93



HydroPower® DI/RO
RESERVEWIEL KUNSTSTOF

Art. Nr.	Info	VPE	€/stuk
20586	1x wiel + beschermkap	1	56,31
20326	Kit beschermkap + sluitring	1 kit	6,36



RO-MEMBRAAN-VERZORGINGSMIDDEL

Art. Nr.	Content	VPE	€/stuk
15436	1 l	1	27,80



HydroPower® RO S
STROOMKABEL MET AARDLEKSCHAKELAAR

Art. Nr.	VPE	€/stuk
23346	1	83,90

ZUIVER WATER FILTERS HYDRO POWER® RO M / RO L



RO M (RO35C)

RO L (RO40C)



1 HydroPower® RO VOORFILTERPATRON „CHLOOR“

Art. Nr.	VPE	€/stuk
ROCAR	1µ	1 115,13

Na vervanging van het **voorfilter (ROCAR)** moet de waarde op het display gereset worden.



2+3 HydroPower® RO MEMBRANE

Art. Nr.	Info	VPE	€/stuk
ROMEM	RO40C bezit 2 membranen vervang altijd samen!	1	472,69
20967	Afdichtring	1	27,09

De 2 **membranen (ROMEM)** hebben een opschrift, dat de stroomrichting aangeeft.

- De pijl moet naar **boven** wijzen.
- De rubberen afdichting moet altijd **boven** worden geplaatst!

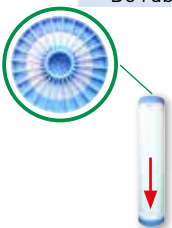

4 HydroPower® RO HARS PATROON

Art. Nr.	VPE	€/stuk
RORES	1	92,19

Plaats het DI harsfilter (RORES) met de goede kant naar boven:

- Blauw deksel met papieren filterinzet naar boven
- Pijl op de behuizing wijst naar beneden

Het verkeerd plaatsen van het filter kan het apparaat beschadigen! De afsluitdop moet goed op zijn plaats zitten!

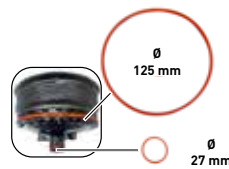

HydroPower® RO AFDICHTINGSSET VOOR SLUITING 1+4 (2 ST.)

Art. Nr.	VPE	€/stuk
ROOR1	voor sluiting 1 (voorfilter)	1 9,00
ROOR4	voor sluiting 4 (hars)	1 8,81

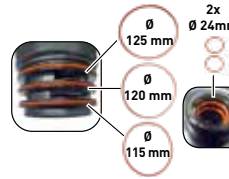

HydroPower® RO AFDICHTINGSSET VOOR SLUITING 2+3 (5 ST.)

Art. Nr.	VPE	€/stuk
ROOR2	voor sluiting 2 (membraan 1)	1 17,46
ROOR3	voor sluiting 3 (membraan 2)	1 17,46



HydroPower® RO AFSLUITDOP

Art. Nr.	VPE	€/stuk
ROOR5	voor tank 4 (hars)	1 2,49



HydroPower® RO SLUITING

Art. Nr.	VPE	€/stuk
ROLD1	voor tank 1 (voorfilter)	1 58,36
ROLD2	voor tank 2 (membraan 1)	1 84,29
ROLD3	voor tank 3 (membraan 2)	1 84,29
ROLD4	voor tank 4 (hars)	1 58,36



HydroPower® RO WATER IN AANSLUITING

Art. Nr.	VPE	€/stuk
ROWIN	1	12,86



HydroPower® RO WATER UIT AANSLUITING

Art. Nr.	VPE	€/stuk
ROWOT	1	19,29



HydroPower® RO DRUKREGELAAR Verlaagt de watertoevoerdruk tot 4 bar

Art. Nr.	VPE	€/stuk
18782	1	50,19



HydroPower® RO DRUKMETER/DISPLAY-ASSEMBLAGE

Art. Nr.	VPE	€/stuk
21855	RO35C	1 157,74
20323	RO40C	1 1.162,29



HydroPower® RO CONCENTRAAT SLANG

Art. Nr.	VPE	€/stuk
ROCHO	1	33,60



HydroPower® DI/RO RESERVEWIEL KUNSTSTOF

Art. Nr.	Info	VPE	€/stuk
20586	1x wiel + beschermkap	1	56,31
20326	Kit beschermkap + sluitring	1 kit	6,36



RO-MEMBRAAN-VERZORGINGSMIDDEL

Art. Nr.	Content	VPE	€/stuk
15436	1 l	1	27,80

HydroPower® RO S STROOMKABEL

Art. Nr.	VPE	€/stuk
19499	1	28,86

ZUIVER WATER FILTERS

HIFLO R060C/S, R030G/C

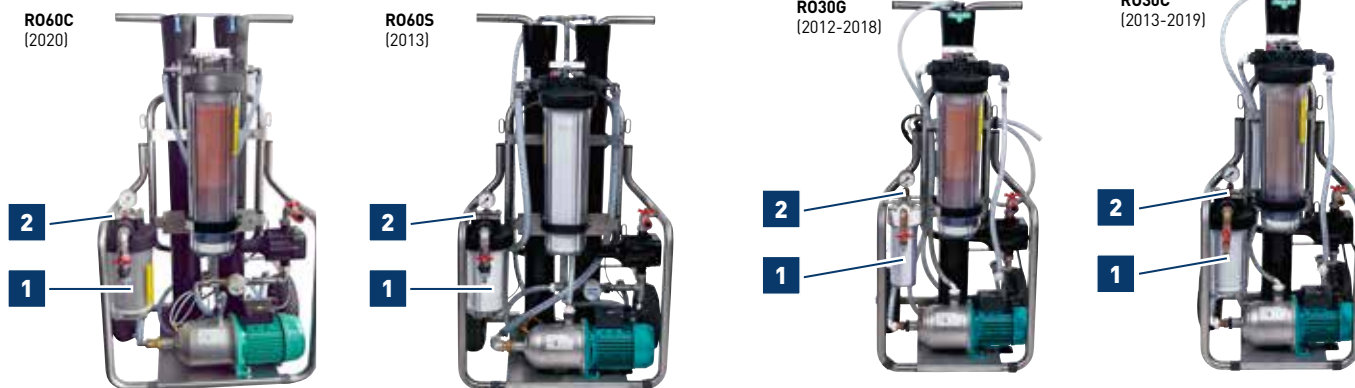

1 VOORFILTER									
	Art. Nr.	Produkt	Info	VPE	€/stuk	R060C	R060S	R030G	R030C
	17522	VOORFILTER GEVAL KLEIN	4,5" x 10"	1	251,73				✓
	22620	VOORFILTER GEVAL KLEIN	4,5" x 10"	1	251,73		✓		
	23428	VOORFILTER GEVAL KLEIN	4,5" x 10"	1	310,00	✓			
	17521	VOORFILTER PATRON (voor 17522)	4,5" x 10"	1	55,49	(✓)	✓		✓
	17509	COMBI-VOORFILTER (FIJNPARTIKEL +CHLOOR) (voor 17522)	4,5" x 10"	1	149,44	✓			✓
	17020	AFDICHTINGSRING VOOR FILTERHUIS 4,5"	4,5"	1	22,57	✓	✓		✓
	17194*	FILTERSLEUTEL 4,5" (voor 17522, 17195)	4,5"	1	22,34	✓	✓		✓
	17195	VOORFILTER GEVAL GROOT ZONDER BORING (voor voorfilter "chloor" 17919)	4,5" x 20"	1	369,44		✓		
	17919	VOORFILTER "CHLOOR" MET AFLSUITRING (voor 17195)	20"	1	206,86		✓		
	16574	VOORFILTERPATRON	2,5" x 10"	1	72,21			✓	
	17188	VOORFILTERPATRON FIJNPARTIKEL (voor 16574)	2,5" x 10"	1	21,36			✓	
	16637*	FILTERSLEUTEL 2,5"	2,5"	1	17,31			✓	

2 WATERINGANG & -UITGANG									
	Art. Nr.	Produkt	Info	VPE	€/stuk	R060C	R060S	R030G	R030C
	18775	WATERAANSLUITING	3/4"	1	4,97	✓	✓	✓	✓
	17024	STANDAARD SLANGAANSLUITING 1/2"	1/2"	1	8,00			✓	✓
	17915	STANDAARD SLANGAANSLUITING 1"	1"	1	8,01	✓	✓		
	16636	MANOMETER INGANGSDRUK		1	21,53	✓	✓	✓	✓
	17607	WATER UIT		1	87,17	✓	✓	✓	✓
	17511	WATER IN ONDERDEEL (na voorfilter)		1	68,41			✓	✓
	21826	ZUIVER WATERSTROOMMETER		1	55,90	✓	✓		



ZUIVER WATER FILTERS



HIFLO R060C/S, R030G/C

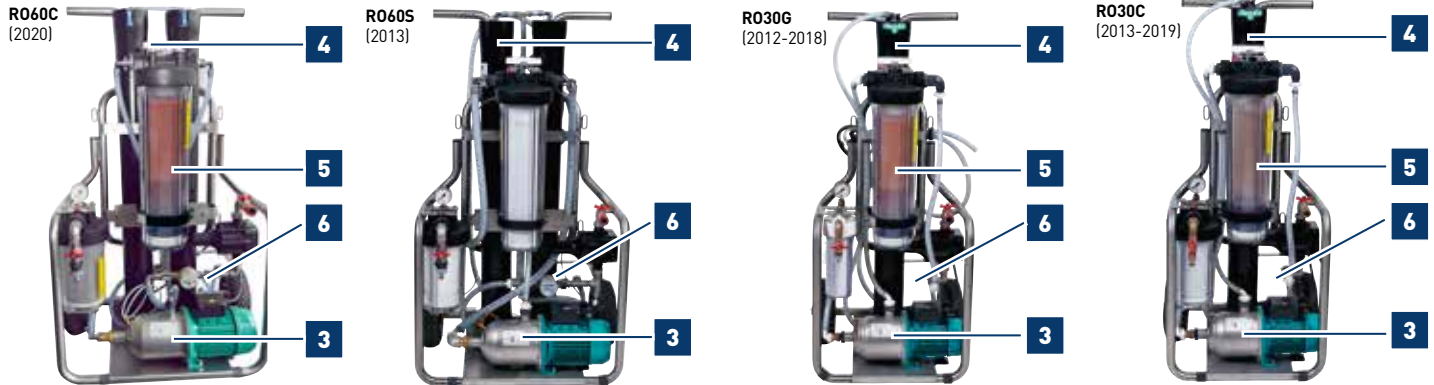







Quality Tools for Smart Cleaning



3		POMP							
Art. Nr.	Produkt	Info	VPE	€/stuk	R060C	R060S	R030G	R030C	
	17918* HIGH PERFORMANCE-POMP R060		1	1.511,96	✓	✓			
	17193* HIGH PERFORMANCE-POMP R030		1	1.529,94			✓	✓	
	21818 POMPBESTURING		1	146,74	✓	✓	✓	✓	

4		MEMBRANEN							
Art. Nr.	Produkt	Info	VPE	€/stuk	R060C	R060S	R030G	R030C	
	17189 MEMBRANE	4" x 40"	1	806,24	✓	✓	✓	✓	
	17190 DRUKPIJP (voor 17189)	4" x 40"	1	773,90	✓	✓	✓	✓	
	17191 MANOMETER BEDRIJFSDRUK		1	91,33	✓	✓	✓	✓	

5		HARS NAFILTER							
Art. Nr.	Produkt	Info	VPE	€/stuk	R060C	R060S	R030G	R030C	
	17196 HARSFILTERBEHUIZING (MET BORING)	4,5" x 20"	1	507,16	✓				
	17020 AFDICTINGSRING VOOR HARSFILTERBEHUIZING 4,5"	4,5"	1	22,57	✓		✓	✓	
	17197 HARS CARTRIDGE 20", LEEG	20"	1	53,50	✓		✓	✓	
	17201 HARS CARTRIDGE 20", GEVULD	20"	1	168,70	✓		✓	✓	
	17079 AFDICTINGSRING (voor 17197, 17201)		1	6,31	✓		✓	✓	
	17194* FILTERSLEUTEL (HARS)	4,5"	1	22,34	✓		✓	✓	

*Kleur kan variëren

ZUIVER WATER FILTERS

HIFLO R060C/S, R030G/C

6 SLANGEN									
Art. Nr.	Produkt	Info	VPE	€/stuk	R060C	R060S	R030G	R030C	
18074	AFDICHRING SLANGVERBINDING 3/4"	3/4"	1	3,40	✓	✓	✓	✓	
18045	AFDICHRING SLANGVERBINDING 1"	1"	1	4,16	✓	✓			
18339	SLANG KOPPELINGEN rechtdoor	3/4"	1	11,89	✓	✓	✓	✓	
18340	SLANG KOPPELINGEN hoekig	3/4"	1	20,63	✓	✓	✓	✓	
17920	CAPILLAIRE BUIS Membranen bij de pomp		1	93,60	✓	✓	✓	✓	
17921	CAPILLAIRE BUIS Concentraat		1	67,74	✓	✓	✓	✓	

TOEBEHOREN									
Art. Nr.	Produkt	Info	VPE	€/stuk	R060C	R060S	R030G	R030C	
15436	MEMBRAAN-VERZORGINGSMIDDEL	4" x 40"	1	27,80	✓	✓	✓	✓	
17605	ZUIGBUIS VOOR MEMBRAAN-VERZORGINGSMIDDEL	4" x 40"	1	14,44			✓		
22886	ZUIGBUIS VOOR MEMBRAAN-VERZORGINGSMIDDEL		1	24,14	✓	✓		✓	
ROTDS	TDS-METER		1	33,37	✓	✓	✓	✓	
16576	TDS-MONITOR		1	138,57	✓	✓	✓	✓	
18322	SENSORKOPPELING		1	9,44	✓	✓	✓	✓	
18782	DRUKREGELAAR (Verlaagt de watertoevoerdruk tot 4 bar)		1	50,19	✓	✓	✓	✓	
18164	DUBBEL SCHROEFDRAAD 3/4"	3/4"	1	4,74	✓		✓	✓	
20669	DUBBEL SCHROEFDRAAD 3/4" - 1"	3/4" - 1"	1	10,90	✓	✓	✓	✓	
18239	DUBBEL SCHROEFDRAAD 1"	1"	1	4,74		✓			
15961	RESERVEWIEL KUNSTSTOF		1	53,40	✓	✓	✓	✓	
17512	CHLOOR TESTSTRIPS		1	143,91	✓	✓		✓	
15731	EINDSTOPPEN VOOR STEEKWAGENGREEP		1	4,49	✓	✓	✓	✓	
16749	TRANSPORTPLUG 3/4"	3/4"	1	2,37			✓	✓	
18238	TRANSPORTPLUG 1"	1"	1	1,69	✓	✓			
19499	STROOMKABEL		1	28,86	✓	✓	✓	✓	

Ø 30mm



ZUIVER WATER FILTERS HYDRO POWER® RO XXL

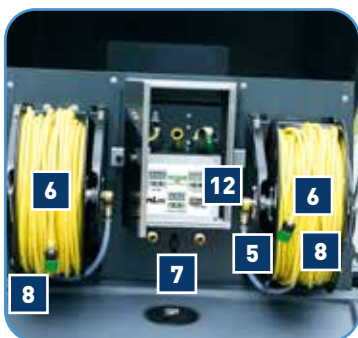

ZUIVER WATER FILTERS HYDRO POWER® RO XXL



Quality Tools for Smart Cleaning

Art Nr.	Produkt	Info	VPE	€/stuk
18998	1 VERGRENDSELBOUT VOOR DEKSEL		1	8,27
18999	2 STEUNPOOT		1	135,34
19063	3 DIAPHRAGM POMP SHURFLO		1	424,19
19064	4 PLASTIC ZEEF		1	15,99
19065	5 SNELKOPPELING PLASTIC		1	13,23
19066	6 SLANGHASPEL ROESTVRIJ STAAL (ZONDER SLANG)	links	1	1.081,23
19067	6 SLANGHASPEL ROESTVRIJ STAAL (ZONDER SLANG)	rechts	1	1.081,23
19068	7 SLANG TRANSPARENT, VERSTERKT		1	1,86
19070	8 SLANG 100M, GEEL (8/12MM)		1	352,20
19076	10 MEMBRAAN		1	936,87
19077	11 DRUKBUIS VOOR MEMBRAAN		1	410,99
19078	12 AFSTANDSBEDIENING	Channel 1-15 LET OP! Gelieve het kanaal te specificeren (zie sticker)	1	175,26
19082	13 WATERTANKDOP		1	14,44
19080	14 CARBON VOORFILTER		1	114,34
19081	15 VOORFILTER CASE KPL.		1	194,04
19099	16 AGM BATTERIJ, FULLRIVER, BLAUW	12V DC, 210A	1	1.424,44
19075	9 BATTERIJ OPLADER VOOR AGM BATTERIJ, FULLRIVER, BLAUW	3A, 230 V, 12 VDC 30A	1	965,56
21634	16 GEL BATTERIJ, EXIDE ES 2400, ZWART	12V DC, 210A	1	1.424,44
21633	9 BATTERIJ OPLADER VOOR GEL BATTERIJ, EXIDE ES 2400, ZWART	3A, 230 V, 12 VDC 30A	1	965,56
19647	PLUG-IN KNIKOPPELING KLEIN/GROOT		1	7,53
19074	SWIVEL MALE T-KOPPELING		1	18,27
19071	SCHROEFKOPPELING VOOR SLANG		1	9,76
19644	EQUAL ELBOW SNELKOPPELING		1	5,71
17421	WATERAANSLUITING, MANNELIJK		1	10,11
19069	SLANG ZWART		1	3,50
18270	SLANGBESCHERMER		1	13,52
15436	RO-MEMBRAAN-VERZORGINGSMIDDEL		1	27,80
18845	BESCHERMING COVER		1	409,21

WATERGELEIDENDE STELEN

nLITE® TELESCOOP STELEN

Elementen



nLITE® Carbon Composite STEELELEMENTEN

Steel	Maat	Element	Elem. 1 - Ø 22mm		Elem. 2 - Ø 25mm		Elem. 3 - Ø 28mm		Elem. 4 - Ø 31mm		Elem. 5 - Ø 34mm		Elem. 6 - Ø 37mm	
			Art. Nr.	€/ stuk	Art. Nr.	€/ stuk	Art. Nr.	€/ stuk	Art. Nr.	€/ stuk	Art. Nr.	€/ stuk	Art. Nr.	€/ stuk
CC16T	1,60 m	2	22787	52,04	22786	59,34								
CC32T	3,20 m	2	22789	77,54	22788	84,81								
CC60T	6,00 m	4	22789	77,54	22792	78,76	22791	79,97	22790	84,81				
CC85T	8,60 m	6	22789	77,54	22792	78,76	22791	79,97	22795	79,97	22794	81,16	22793	86,01

nLITE® Carbon 24K STEELELEMENTEN

Steel	Maat	Element	Elem. 1 - Ø 22mm		Elem. 2 - Ø 25mm		Elem. 3 - Ø 28mm		Elem. 4 - Ø 31mm		Elem. 5 - Ø 34mm		Elem. 6 - Ø 37mm	
			Art. Nr.	€/ stuk	Art. Nr.	€/ stuk	Art. Nr.	€/ stuk	Art. Nr.	€/ stuk	Art. Nr.	€/ stuk	Art. Nr.	€/ stuk
CF60T	6,00 m	4	22799	145,49	22798	157,63	22797	169,76	22796	181,89				
CF86G	8,60 m	6	22799	145,49	22798	157,63	22797	169,76	22802	177,04	22801	189,17	22800	201,30
CF33G	3,20 m	4									22804	189,17	22803	201,30



VERVANGEN VAN STEELELEMENTEN:

1. Verwijder de onderste schroef van de klem. Klemtape moet wellicht worden vervangen (zie hieronder).
2. Trek het steelelement voorzichtig met de klem naar boven.

ATTENTIE: Aan het einde van elk element bevindt zich een aanslaglint, dit mag bij het uitnemen en weer inbrengen niet beschadigd worden!

nLITE® SmartLock KLEMMEN



Art. Nr.	Info	VPE	€/stuk
22817	Element 1; Ø 22mm	1	12,01
22818	Element 2; Ø 25mm	1	12,74
22819	Element 3; Ø 28mm	1	13,23
22820	Element 4; Ø 31mm	1	13,94
22821	Element 5; Ø 34mm	1	14,44
22822	Element 6; Ø 37mm	1	15,17

SMART LOCK KLEMMEN VERVANGEN:



nLITE® GREP



Art. Nr.	Info	VPE	€/stuk
22814	Ø 25mm [CC16T, CC32T]	1	5,94
22815	Ø 31mm [CC60T / CF60T]	1	7,16
22816	Ø 37mm [CC85T / CF86G / CF33G]	1	8,37

Art. Nr.	Produkt	VPE	€/stuk
23224	Dubbelzijdige plakband 16,50m voor Smart Lock klemmen	1	24,90
NLPCP	nLITE® beschermkap	1	6,06
NLHCC	nLITE® uitbreidingsadapter	1	59,44
NLHKP	nLITE® clips voor geleiding slang buitenlangs de steel	1	9,57
23241	nLITE® borstelsockel draaibaar	1	14,44
23242	nLITE® borstelsockel vast	1	10,80
22137	nLITE® borstelsockel bevestigingsschroef (1x)	1	0,36
23240	nLITE® zachte stootrand	1 kit (5)	9,10
NLR28	nLITE® strip met sproeikop (Rinse Bar) 28cm	1	7,16
NLR41	nLITE® strip met sproeikop (Rinse Bar) 41cm	1	7,89
23243	nLITE® sproeiers balk 28 cm	1	7,16
23244	nLITE® sproeiers balk 41 cm	1	9,57

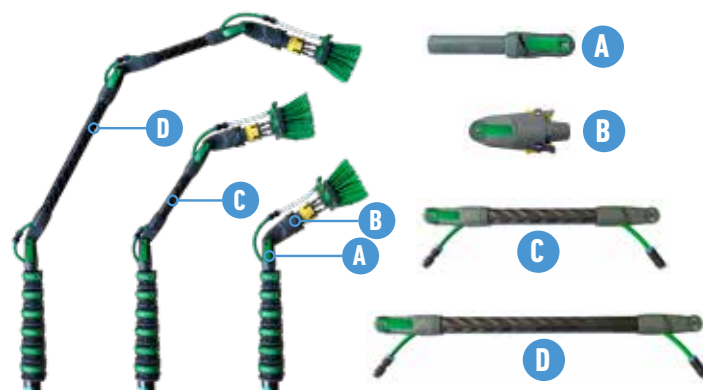

nLITE® HOEKADAPTER ELEMENTE

Art. Nr.	Info	VPE	€/stuk
22805	Element A - steeladapter	1	21,71
22806	Element B - borsteladapter	1	9,57
22807	Element C - kort (incl. slang & snelkoppeling)	1	47,19
22808	Element D - lang (incl. slang & snelkoppeling)	1	55,69

WATERGELEIDENDE STELEN

nLITE® SNELKOPPELING, HOES



Quality Tools for Smart Cleaning

HOES



nLITE® DUROFLEX

Ø 8 mm	DLS25	1
Version:	Standaard	
Lengte:	25 m	
VPE	1	
€/st.	60,56	



nLITE® Connect HOES

Ø 8 mm	NL25G	3
Version:	Standaard	
Lengte:	25 m	
VPE	1	
€/st.	37,41	



nLITE® HOES VORR BORSTEL

Ø 8 mm	22813	5
Version:	Borstel	
Lengte:	20 cm	
VPE	1	
€/st.	5,94	



nLITE® DUROFLEX HOGE PRESTATIES

Ø 10 mm	DLH25	2
Version:	hoge prestaties	
Lengte:	25 m	
VPE	1	
€/st.	121,21	



nLITE® Connect SLANG MET HOGE PRESTATIES

Ø 12 mm	NLH25	4
Version:	hoge prestaties	
Lengte:	25 m	
VPE	1	
€/st.	102,41	

⊘ = Binnendiameter

SNELKOPPELING



6>6 mm	NLQUI	6
VPE	1 Kit	
€/Kit	15,87	



8>8 mm	22809	8
VPE	5 (Kit)	
€/Kit	28,99	



8>2x 6 mm	23238	10
VPE	5 (Kit)	
€/Kit	64,29	



6>8 mm	23009	7
VPE	5 (Kit)	
€/Kit	48,41	



10>8mm	22810	9
VPE	5 (Kit)	
€/Kit	48,41	



8>8 mm	22811	11
VPE	1	
€/st.	8,37	

CONNECTOREN VOOR HOES



Ø 6 mm	23232	12
VPE	5 (Kit)	
€/Kit	25,31	



Ø 8 mm	23237	13
VPE	5 (Kit)	
€/Kit	25,31	

WATERSTROOM ADAPTER



Ø 8 mm	NLWVI	14
VPE	1	
€/st.	24,90	



Ø 10 mm	22812	15
VPE	1	
€/st.	29,90	

FILTERAANSLUITING



Ø 8 mm	CTHLC	16
VPE	1	
€/st.	7,09	



Ø 10 mm	23236	17
VPE	1	
€/st.	13,77	

AANSLUITVOORBEEDEN



1 (DLS25)



8 (22809)



NGS15/NGS30/NGS45
NGC15/NGC30/NGC45



2 (DLH25)



9 (22810)



NGS15/NGS30/NGS45
NGC15/NGC30/NGC45



3 (NL25G)



12 (23232)



7 (23009)



NGS15/NGS30/NGS45
NGC15/NGC30/NGC45



4 (NLH25)



8 (22809)



NGS15/NGS30/NGS45
NGC15/NGC30/NGC45



WATERGELEIDENDE STELEN

nLite® CONNECT



ZOLANG DE VOORRAAD STREKT



nLite® Connect ULTRA HIMOD BASELEMENT (UH67G)

Art. Nr.	Ø mm	Segment	Klem	VPE	€/stuk
18608	26	1	●	1	386,47
18610	29	2	●	1	401,16
18611	32	3	●	1	449,06
18612	35	4	●+●	1	491,50



nLite® Connect ULTRA HIMOD UITBREIDINGSELEMENT (UH35G)

Art. Nr.	Ø mm	Segment	Klem	VPE	€/stuk
18613	32	1	-	1	454,54
18614	35	2	●+●	1	491,50

nLite® Connect HIMOD BASELEMENT (UC67G)

Art. Nr.	Ø mm	Segment	Klem	VPE	€/stuk
17254	26	1	●	1	260,23
17260	29	2	●	1	282,63
17266	32	3	●	1	302,76
17272	35	4	●+●	1	345,11

nLite® Connect HIMOD UITBREIDINGSELEMENT (UC35G)

Art. Nr.	Ø mm	Segment	Klem	VPE	€/stuk
17279	32	1	-	1	316,23
17396	35	2	●+●	1	345,11

nLite® Connect CARBON BASELEMENT (CT67G)

Art. Nr.	Ø mm	Segment	Klem	VPE	€/stuk
17253	26	1	●	1	157,24
17259	29	2	●	1	165,77
17265	32	3	●	1	173,00
17271	35	4	●+●	1	218,23

nLite® Connect CARBON UITBREIDINGSELEMENT (CT35G)

Art. Nr.	Ø mm	Segment	Klem	VPE	€/stuk
17278	32	1	-	1	176,04
17394	35	2	●+●	1	218,23

*Indien een steelement niet meer beschikbaar is in de kwaliteiten glasvezel of hybride, zal het ter vervanging in carbon worden geleverd tegen dezelfde prijs.

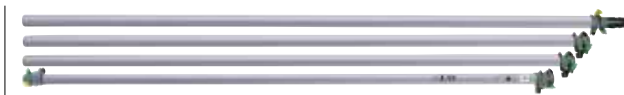

nLite® Connect MASTERELEMENT ALUMINIUM (AN45G / AN60G)

Art. Nr.	Ø mm	Segment	Klem	VPE	€/stuk
17828	26	1 (4,50 m)	●	1	23,86
17829	29	2 (4,50 m)	●	1	24,54
17830	32	3 (4,50 m)	●	1	25,13
17831	35	4 (4,50 m)	●+●	1	38,20
17824	26	1 (6,00 m)	●	1	26,91
17825	29	2 (6,00 m)	●	1	27,74
17826	32	3 (6,00 m)	●	1	28,63
17827	35	4 (6,00 m)	●+●	1	41,34



nLite® Connect UITBREIDINGSELEMENT ALUMINIUM (AN30G)

Art. Nr.	Ø mm	Segment	Klem	VPE	€/stuk
17832	32	1 (3,00 m)	-	1	27,17
17833	35	2 (3,00 m)	●+●	1	40,71

nLite® Connect KLEMMEN

Elem. 1 - Ø 26mm		Elem. 2 - Ø 29mm		Elem. 3 - Ø 32mm		Elem. 4 - Ø 35mm		VPE
Art. Nr.	€/stuk	Art. Nr.	€/stuk	Art. Nr.	€/stuk	Art. Nr.	€/stuk	
23227	● 6,84	23228	● 7,00	23229	● 7,06	23231	● 8,67	1
23233	● 6,11	[ohne Schlauch-Clip]				23230	● 8,67	1

geel hendel

grijs hendel

23231 = nLite Connect element 4 bovenste steeleinde
23230 = nLite Connect basis & uitbreiding lagere steeleinde

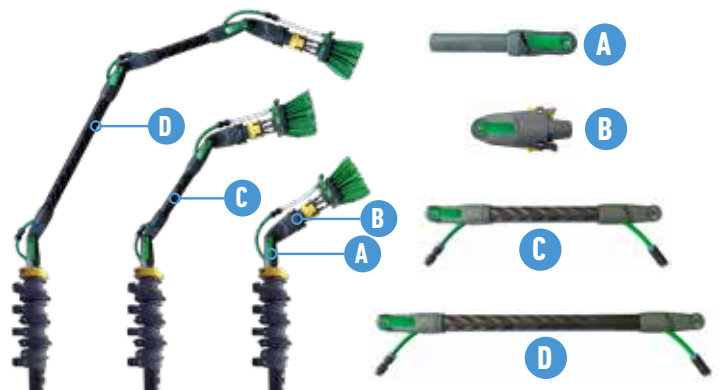

nLite® Connect HOEKADAPTER ELEMENTE

Art. Nr.	Info	VPE	€/stuk
NGC00	Element A - steeladapter	1	21,71
22806	Element B - borsteladapter	1	9,57
22807	Element C - kort (incl. slang & snelkoppeling)	1	47,19
22808	Element D - lang (incl. slang & snelkoppeling)	1	55,69

nLite® MULTILINK HOEKADAPTERS

Art. Nr.	Afmeting	Gewicht	Materiaal	VPE	€/stuk
FTG05	15 cm	50 g	Kunststof	1	7,30



WATERGELEIDENDE STELEN

nLite® ONE, nLite® CONNECT

ZOLANG DE VOORRAAD STREKT

nLite® Connect EINDSTUK



Kunststof beschermkap met rubber

- Voorkomt beschadiging van het steeleinde
- Zijdelingse opening voor de slang
- Eenvoudig in te steken in de steel en met klem te bevestigen.

Art. Nr.	VPE	€/stuk
TMECP	1	7,09



nLite® Connect SLANGCLIPS

Art. Nr.	VPE	€/stuk
17149	10	0,67



nLite® Connect GEREEDSCHAP ADAPTER

Kunststof adapter voor het bevestigen van hulpmiddelen om de nLite® slang

- FTTHR: Levert schroefdraad voor het vastschroeven van een borstel
- HFNLC: Conus adapter voor klassiek reinigingsgereedschap.

Art. Nr.	VPE	€/stuk
FTTHR	1	7,09
HFNLC	1	8,24



SLANGENSETS

- 1x male-adapter voor slangwagen
- 1x female-adapter voor steel

Art. Nr.	Maat	Ø binnen	VPE	€/stuk
PH10Y	100 m	5mm	1	102,49



Universele klittenbanden voor ø van 20-70 mm

Speciale nLite®-klem voor een ø van 35 mm

HiFlo Control

Waterstroom altijd regelbaar

- past op alle stelen met een ø van 20-70 mm
- voor slangen met een buitendiameter van 8 of 9 mm

Art. Nr.	Info	VPE	€/stuk
TMOON	Klemmen, die op iedere nLite® Connect-steel passen	1	4,06
TMOOT	Klittenbanden, die op universele stelen passen	1	4,06



nLite® Connect SPROEIJERS

Snelsluitingssproeiers voor nLite® borstels

- NLBJF: Voor het opsproeien van water, genereert een constante waterfilm
- NLBJP: Voor het spoelen en verwijderen van vuil met druk
- Let op: Hoe meer sproeiers er gebruikt worden, des te geringer wordt de waterdruk

Art. Nr.	Info	VPE	€/kit
NLBJF	1 Set = 2 sproeiers	1 kit	6,46
NLBJP	1 Set = 2 sproeiers	1 kit	6,46

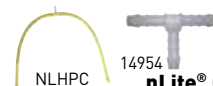

nLite® Connect BORSTEL AANSLUITINGSKIT 5MM

Verbindt twee sproeiers met de borstel en zorgt voor de aansluiting met de slangslang

- NLHPC: 2 slangstukken Ø 5mm + 1 T-stuk 14954
- 14954: T-stuk - verbindt van slangstukken.

Art. Nr.	Info	VPE	€/stuk
NLHPC	Aansluitingskit 5mm	1	5,06
14954	T-stuk 5mm	1	1,36



nLite® Connect BORSTEL AANSLUITINGSKIT 8MM

Verbindt twee sproeiers met de borstel en zorgt voor de aansluiting met de slangslang

- NLHPA: 2 slangstukken Ø 8mm + 1 T-stuk 20478
- 20477: Stekkernippel voor aansluiting van 8 mm slang met T-stuk 20478
- 20478: T-stuk - verbindt van slangstukken.

Art. Nr.	Info	VPE	€/kit
NLHPA	Aansluitingskit 8mm	1	19,29
23232	Stopnippel 6mm	5 (kit)	25,30
23237	Stopnippel 8mm	5 (kit)	25,30
23238	T-stuk 8mm	5 (kit)	64,29



nLite® Connect BORSTELSOKKEL

Reservesokkel om borstel en hoekadapter te verbinden.

- Kan omgedraaid worden, om de hoek van de borstel en de indeling van de sproeiers te veranderen.

Art. Nr.	VPE	€/stuk
NLBRS	1	8,67

KLASSIEKE GLASREINIGING

TELESCOOPSTELLEN & WISSERS

OPTI LOC



OptiLoc 3-DELIG, BUITENSTEEL Ø29MM

Art. Nr.	Maat	Voor	VPE	€/stuk
AP125	1,00 m	ED370	1	24,26
AP150	1,50 m	ED450	1	37,48
AP200	2,00 m	ED600	1	49,14

OptiLoc 3-DELIG, MIDDENSTEEL Ø25MM

Art. Nr.	Maat	Voor	VPE	€/stuk
MR125	1,25 m	ED370	1	18,94
MR150	1,50 m	ED450	1	25,24
MR200	2,00 m	ED600	1	27,88

OptiLoc & TelePlus BIN STEEL Ø21MM

Art. Nr.	Maat	Voor	VPE	€/stuk
IR060	0,60 m	EZ120, ED180	1	11,12
IR110	1,00 m	ED370	1	14,10
IR125	1,25 m	EZ250, ED370, TZ250, TD370, TV500, TF620	1	15,66
IR150	1,50 m	EZ300, ED450, TD370	1	18,52
IR200	2,00 m	EZ400, ED600, TZ400, TD600, TV800, TF100	1	22,52
14887	2,50 m	EZ500, ED750	1	23,76
IR300	3,00 m	EZ600, ED900	1	30,76

OptiLoc GREEP

Art. Nr.	Maat	Voor	VPE	€/stuk
GR250	25 mm	OptiLoc EZ...	5	3,34
GR300	29 mm	OptiLoc ED...	5	3,84

OptiLoc SLUITING

Art. Nr.	Maat	Voor	VPE	€/stuk
VS250	25 mm	OptiLoc EZ + ED Sect.2	5	8,92
VS300	29 mm	OptiLoc ED Section 3	5	12,24

ERGOTEC® NINJA



ErgoTec® NINJA CLIPS

Art. Nr.	VPE	€/stuk
PPLUG	5 Sets	10,50

TELE PLUS



TelePlus SCHROEFDRAADKLEM

Art. Nr.	Maat	Voor	VPE	€/stuk
GKL25	25 mm	TelePlus basis	10	1,84

TelePlus SCHROEFDRAADPLAATJE

Art. Nr.	Maat	Voor	VPE	€/stuk
GKL29	29 mm	TelePlus 3+4+5	10	1,92

TelePlus SLUITING

Art. Nr.	Maat	Voor	VPE	€/stuk
YE250	25 mm	Sect. 2	5	5,38
YE290	29 mm	Plus 3	5	6,20
YE330	33 mm	Plus 4	5	8,82
YE370	37 mm	Plus 5	5	11,00

TelePlus GREEP

Art. Nr.	Maat	Voor	VPE	€/stuk
TPG37	37 mm	Plus 5	5	3,22

BUCKET ON A BELT



Bucket On A Belt PROTECTOR

Art. Nr.	Info	VPE	€/stuk
BBPRO	voor BB010	1	2,04

2,04

EMMER 18 L



ONDERDEL VOOR INWASSERS

Art. Nr.	Info	VPE	€/stuk
11113	voor QB120	1	4,40

ONDERDEL VOOR WISSERS

Art. Nr.	Info	VPE	€/stuk
13874	voor QB120	1	2,66

VISA VERSA



VisaVersa® GRIP

Art. Nr.	Info	VPE	€/stuk
VH000	voor VPxxx	1	7,50

VisaVersa® KOP

Art. Nr.	Info	VPE	€/stuk
VS000	voor VPxxx	1	8,82

KLASSIEKE GLASREINIGING SCHRAPER



Quality Tools for Smart Cleaning

ERGO TEC® NINJA



ErgoTec®NINJA BESCHERMKAP

Art. Nr.	Info	VPE	€/stuk
18103	10cm voor EN100	1	3,04
18085	15cm voor EN150	1	3,02



ErgoTec®NINJA SLEUVEN

Art. Nr.	Info	VPE	€/stuk
18108	10cm, voor EN100	1	1,96
18098	15cm, voor EN150	1	1,96

ERGO TEC®



ErgoTec® Glasscraper BESCHERMKAP

Art. Nr.	Info	VPE	€/stuk
EGC10	10cm voor EG100	1	3,02
EGC15	15cm voor EG150	1	3,02



ErgoTec® Glasscraper SLEUVEN

Art. Nr.	Info	VPE	€/stuk
EGH10	10cm, voor EG100	1	2,34
EGH15	15cm, voor EG150	1	2,34

OPPERVLAKTESCHRAPERS



ErgoTec® Schrapper BESCHERMKAP

Art. Nr.	Info	VPE	€/stuk
15767	10cm, voor SH000, SH250, LH120	10	3,02

TRIM



Trim PLASTIC DOOS, VOOR MESSEN

Art. Nr.	Info	VPE	€/stuk
PLET0	voor TM100, TR100	10	2,38

RAAM BINNENREINIGING

STINGRAY® OS

STINGRAY 

The Ultimate Indoor Cleaning Tool



Stingray OS BASIS HANDAPPARAAT

Art. Nr.	Inhoud	VPE	€/stuk
SROHH	incl. opvulbare fles en 2x alkalische AA baerij	1	150,38



Stingray OS OPVULBARE FLES

Art. Nr.	Grootte	VPE	€/stuk
SRBT1	150 ml	1	20,90



ONDERHOUDSREINIGING

erGO!, DUBBELE ROLEMMER & BEZEM

UNGER[®]

Quality Tools for Smart Cleaning

erGO! clean & wax

erGO!



erGO! DISPENSER SLANG

Voor erGO! klap-straaleenheid FAVAS

Art. Nr.	VPE	€/stuk
FADTS	1 kit (5 st.)	4,92



erGO! KLITTENBAND VERVANG-STRIPS

Voor erGO! klittenband mop FAVMH

Art. Nr.	VPE	€/stuk
FAVMK	1 kit (2 st.)	3,63



erGO! KLAP-STRAALEENHEIDT

Voor erGO! stelen FAEPL en FASPL

Art. Nr.	VPE	€/stuk
FAVAS	1	17,52



HOLD UP



HOLD UP RESERVERUBBER

HU450, HU900

Art. Nr.	VPE	€/stuk
EG450	10	4,70



SMART COLOR DUBBELE ROLEMMER



SmartColor KUNSTSTOF PERS

Art. Nr.	kleur	VPE	€/stuk
SPREG	●	1	92,94



SmartColor RESERVEWIELEN

Art. Nr.	Inhoud	VPE	€/stuk
17891	4 stuks	1 kit	4,30



ERGO SCHOP



ErgoSchop VERVANGING BEZEM

Art. Nr.	VPE	€/stuk
15494	1	6,62





Quality Tools for Smart Cleaning

WANNEER JE INFORMATIE NODIG HEBT – JE VINDT ONS OVERAL

Ontdek alle wetenswaardigheden over de **UNGER** producten en de nieuwste reinigingstechnologieën op onze homepage ungerglobal.com en onze social media kanalen:



BEUR



Geldig vanaf 1-1-2024. Voor de bestellingen van onze zakelijke handelsklanten en onze leveringen zijn uitsluitend de algemene leverings- en betalingsvoorwaarden van de **UNGER Germany GmbH** in de meest recente versie van toepassing, te bekijken op www.ungerglobal.com. Alle prijzen zijn vrijblijvend aanbevolen detailhandelsprijzen exclusief btw. Alle informatie onder voorbehoud, wijzigingen voorbehouden.

UNGER Germany GmbH

Piepersberg 44
D-42653 Solingen
GERMANY
Tel.: (49) 0212 2207 260
Fax: (49) 0212 2207 222
ungereurope@ungerglobal.com

UNGER Enterprises LLC

425 Asylum Street
Bridgeport, CT 06610
USA
Tel.: (1) 800 431 2324
Fax: (1) 800 367 1988
unger@ungerglobal.com

UNGER UK Ltd.

F1 Deansgate, 62-70 Tettenhall Road
Wolverhampton, WV1 4TH
UNITED KINGDOM
Tel.: (44) 01902 306633
Fax: (44) 01902 306644
ungeruk@ungerglobal.com



www.ungerglobal.com